

JVC

English

中文

MICRO COMPONENT SYSTEM

微型组合音响

UX-H35 — Consists of CA-UXH35 and SP-UXH35
由 CA-UXH35 及 SP-UXH35 组成

UX-H33 — Consists of CA-UXH33 and SP-UXH33
由 CA-UXH33 及 SP-UXH33 组成

UX-H30 — Consists of CA-UXH30 and SP-UXH30
由 CA-UXH30 及 SP-UXH30 组成

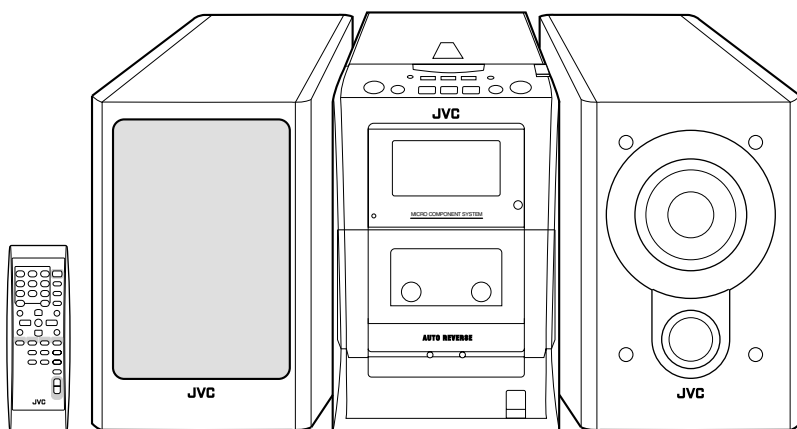

COMPACT
disc
DIGITAL AUDIO

INSTRUCTIONS 使用说明书

For Customer Use:

Enter below the Model No. and Serial No. which are located either on the rear, bottom or side of the cabinet. Retain this information for future reference.

Model No. _____

Serial No. _____

GVT0101-003A
[U, UJ]

Warnings, Cautions and Others

警告，注意及其他须知事项

CAUTION— (standby/on) button!

Disconnect the mains plug to shut the power off completely (all lamps and indications go off). The  (standby/on) button in any position does not disconnect the mains line.

- When the unit is on standby, the STANDBY lamp lights red.
- When the unit is turned on, the STANDBY lamp goes off.

The power can be remote controlled.

注意 — (待机/开) 开关！

将主电源插头从插座上拔出以完全关闭电源（全部灯光和指示灯熄灭）。 (待机/开) 开关处于任何状况也没有完全切断主线。

- 当本机处于备用模式时，STANDBY 灯将亮起红色。
- 当本机被启动时，STANDBY 灯将熄灭。

电源开关可用遥控器控制。

CAUTION

To reduce the risk of electrical shocks, fire, etc.:

1. Do not remove screws, covers or cabinet.
2. Do not expose this appliance to rain or moisture.

注意

为了防止触电，火灾等危险：

1. 请勿擅自卸下螺丝钉，盖子或机壳。
2. 切勿让本机受雨淋或置于潮湿环境中。

CAUTION

- Do not block the ventilation openings or holes. (If the ventilation openings or holes are blocked by a newspaper or cloth, etc., the heat may not be able to get out.)
- Do not place any naked flame sources, such as lighted candles, on the apparatus.
- When discarding batteries, environmental problems must be considered and local rules or laws governing the disposal of these batteries must be followed strictly.
- Do not expose this apparatus to rain, moisture, dripping or splashing and that no objects filled with liquids, such as vases, shall be placed on the apparatus.

注意

- 请勿堵塞通风口或通风孔。
(如果通风口或通风孔被报纸或布等堵塞，热量将无法散出。)
- 请勿在本设备上放置任何裸露的火源，如点燃的蜡烛。
- 处理废弃电池时，必须考虑环境问题，并严格遵守当地关于处理废弃电池的有关法律或规定。
- 切勿将本装置暴露于雨水所及、潮湿、滴水或易于溅起水花的地方，亦不要将任何装满液体的物件（如花瓶）放置在本装置上。

IMPORTANT FOR LASER PRODUCTS

镭射产品的重要说明

REPRODUCTION OF LABELS

标签内容说明

① CLASSIFICATION LABEL ON EXTERIOR SURFACE

① 位于机表的分类说明文

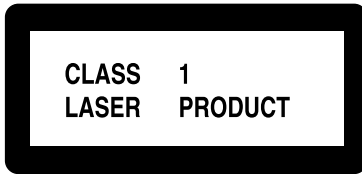

② WARNING LABEL INSIDE THE UNIT

② 位于机内的警告说明文

CAUTION: Invisible laser radiation when open and interlock failed or defeated. AVOID DIRECT EXPOSURE TO BEAM. (e)	ADVARSEL: Usynlig laserstråling ved åbning, når sikkerhedsafbrydere er ude af funktion. Undgå udsættelse for stråling. (d)	WARNING: Osynlig laserstråling når denna del är öppnad och spårren är urkopplad. Betrakta ej strålen. (s)	VARO: Avattaessa ja suojalukitus ohitettaessa olet alttiina näkymättömälle lasersäteilylle. Älä katso säteeseen. (f)
--	---	--	---

1. CLASS 1 LASER PRODUCT
2. **CAUTION:** Invisible laser radiation when open and interlock failed or defeated. Avoid direct exposure to beam.
3. **CAUTION:** Do not open the top cover. There are no user serviceable parts inside the unit; leave all servicing to qualified service personnel.

1. 一级镭射产品
2. **注意：**当内部锁定装置失效或者损坏后，打开盖板可能会产生不见的镭射辐射。应避免受到光束直接照射。
3. **注意：**请勿打开顶盖板，本机内部没有用户可自行维修的部件；所有维修工作应由有资格的人员完成。

CAUTION: Proper Ventilation

To avoid risk of electric shock and fire, and to prevent damage, locate the apparatus as follows:

- 1 Front: No obstructions and open spacing.
- 2 Sides/ Top/ Back: No obstructions should be placed in the areas shown by the dimensions below.
- 3 Bottom: Place on a level surface. Maintain an adequate air path for ventilation by placing on a stand with a height of 10 cm or more.

注意：正确通风

为避免发生触电和火警的危险，及防止本机受损，请将本机如下放置：

1. 前面：没有障碍物及地方开阔。
2. 侧面 / 顶面 / 背面：在图中所示范围中，不应放置任何障碍物。
3. 底部：放置在水平面上。放置在一个高 10 厘米或以上的台面上，以保持足够的通风道。

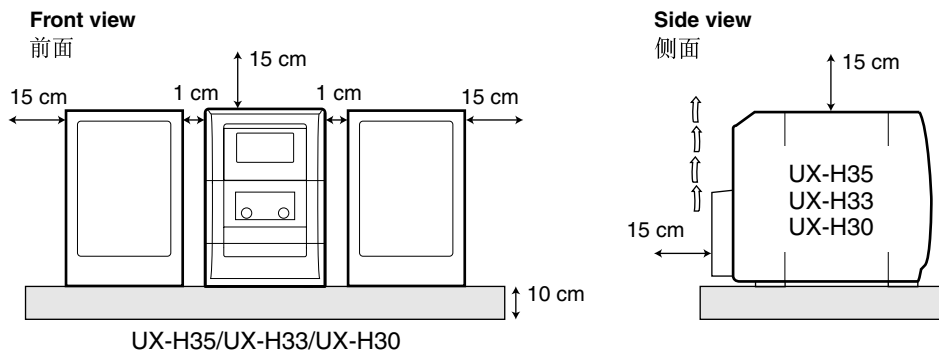

Introduction

We would like to thank you for purchasing one of our JVC products. Before operating this unit, read this manual carefully and thoroughly to obtain the best possible performance from your unit, and retain this manual for future reference.

About This Manual

This manual is organized as follows:

- **The manual mainly explains operations using the buttons on the remote control. You can use the buttons both on the remote control and on the main unit for the same operations if they have the same or similar names (or marks), unless mentioned otherwise.**
- Basic and common information that is the same for many functions is grouped in one place, and is not repeated for each procedure. For instance, we do not repeat the information about turning on/off the unit, setting the volume, changing the sound effects, and others, which are explained in the section “Common Operations” on pages 10 and 11.
- The following symbols are used in this manual:



Gives you warning and caution to prevent damage or risk of fire/electric shock.

Furthermore, it gives you information about what is not good for obtaining the best possible performance from the unit.



Gives you information and hints you should know.

Precautions

Installation

- Install in a place which is level, dry and neither too hot nor too cold—between 5°C and 35°C.
- Install the unit in a location with adequate ventilation to prevent internal heat buildup in the unit.
- Leave sufficient distance between the unit and the TV.
- Keep the speakers away from the TV to avoid interference with TV.



DO NOT install the unit in a location near heat sources, or in a place subject to direct sunlight, excessive dust or vibration.

Power sources

- When unplugging the unit from the wall outlet, always pull on the plug, not the AC power cord.



DO NOT handle the AC power cord with wet hands.

Moisture condensation

Moisture may condense on the lens inside the unit in the following cases:

- After starting heating in the room
- In a damp room
- If the unit is brought directly from a cold to a warm place

Should condensation occur, the unit may malfunction. In this case, leave the unit turned on for a few hours until the moisture evaporates, unplug the AC power cord, then plug it in again.

Others

- Should any metallic object or liquid fall into the unit, unplug the power cord and consult your dealer before operating any further.
- If you are not going to operate the unit for an extended period of time, unplug the power cord.



DO NOT disassemble the unit since there are no user serviceable parts inside.

If anything goes wrong, unplug the power cord and consult your dealer.

Location of the Buttons	3
Main Unit	3
Remote Control	5
Getting Started	6
Supplied Accessories	6
Connecting Antennas	6
Connecting Speakers	7
Connecting Other Equipment	8
Adjusting the Voltage Selector	8
Putting the Batteries into the Remote Control	9
Common Operations	10
Setting the Clock	10
Setting the AM Tuner Interval Spacing	10
Turning On the Power	11
Adjusting the Volume	11
Adjusting the Tone (Bass/Treble)	11
Reinforcing the Bass Sound	11
Listening to FM and AM Broadcasts	12
Tuning in to a Station	12
Presetting Stations	12
Tuning in to a Preset Station	13
Playing Back Discs	14
Playing Back the Entire Disc—Normal Play	14
Basic Disc Operations	15
Programming the Playing Order of the Tracks —Program Play	15
Playing at Random—Random Play	16
Repeating Tracks—Repeat Play	16
Playing Back Tapes	17
Playing Back a Tape	17
Recording	18
Recording on a Tape	18
Disc Direct Recording	19
One Track Recording	19
Using the Timers	20
Using Daily Timer and Recording Timer	20
Using Snooze Timer	22
Using Sleep Timer	22
Maintenance	23
Troubleshooting	24
Specifications	24

Location of the Buttons

Become familiar with the buttons on your unit.

Main Unit

Top view

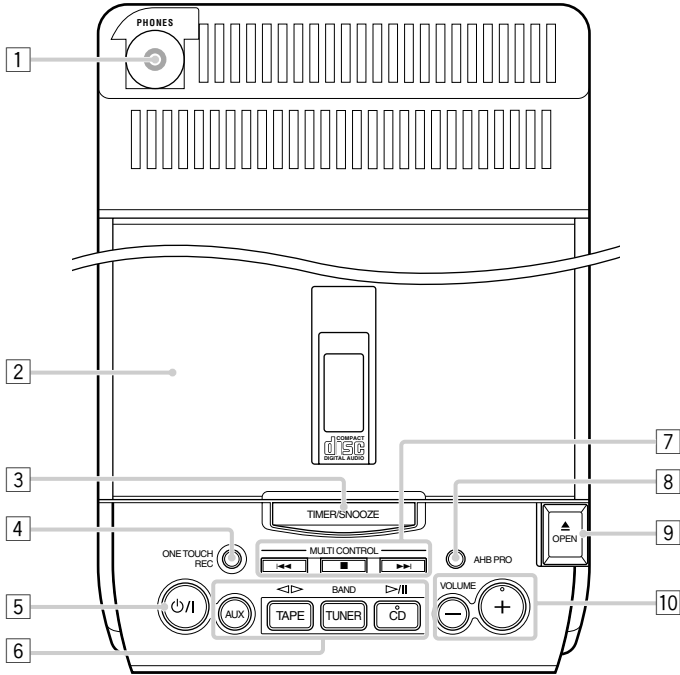

Front view

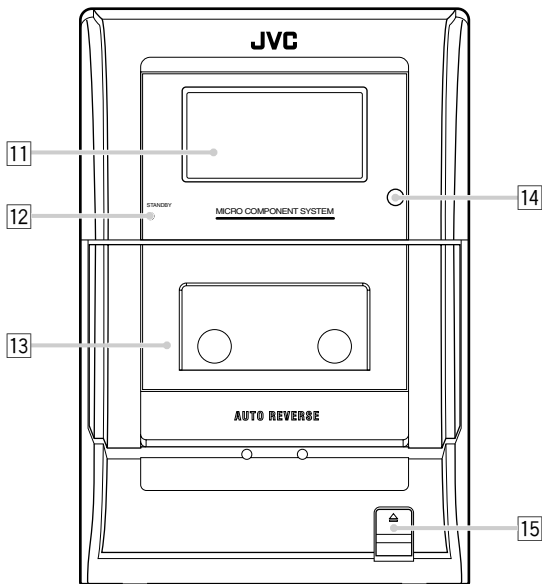

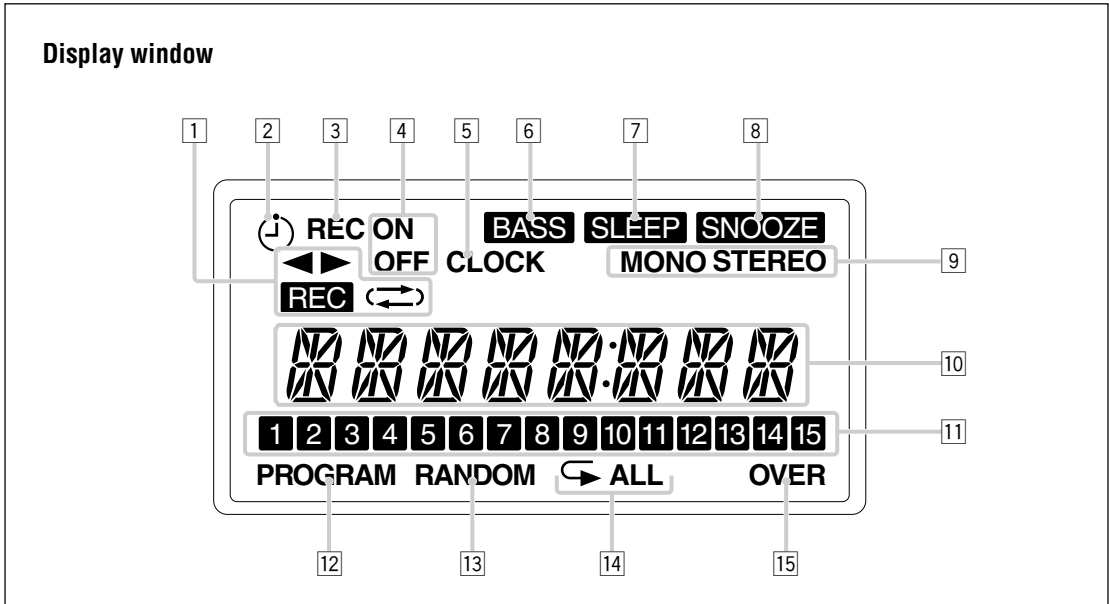

See the pages in parentheses for details.

Main unit

- 1 PHONES jack (11)
- 2 Disc cover
- 3 TIMER/SNOOZE button (10, 20 – 22)
- 4 ONE TOUCH REC (recording) button (18, 19)
- 5 Φ /I (standby/on) button (10, 11, 21)
- 6 Source buttons
 - AUX, \triangleleft \triangleright TAPE, BAND TUNER, and \triangleright /|| CD

Pressing one of these buttons also turns on the unit.
- 7 MULTI CONTROL buttons
 - \triangleleft (reverse skip), \blacksquare (stop), and \triangleright (forward skip)
- 8 AHB (Active Hyper Bass) PRO button (11)
- 9 \blacktriangle OPEN (disc cover open) button (14)
- 10 VOLUME + / - buttons (11)
- 11 Display window
- 12 STANDBY lamp (11)
- 13 Cassette holder
- 14 Remote sensor
- 15 \triangle (cassette holder open) button (17 – 19)

Display window

- 1 Tape operation indicators
 - \triangleleft \triangleright (tape direction), **REC** (recording), and \leftrightarrow (reverse mode)
- 2 Φ (timer) indicator
- 3 REC (recording timer) indicator
- 4 ON/OFF (timer on-time/off-time) indicators
- 5 CLOCK indicator
- 6 **BASS** indicator
- 7 **SLEEP** indicator
- 8 **SNOOZE** indicator
- 9 MONO and STEREO indicators
- 10 Main display
 - Shows the source name, frequency, etc.
- 11 Track calender indicators
- 12 PROGRAM indicator
- 13 RANDOM indicator
- 14 Repeat indicators
 - \curvearrowright and ALL
- 15 OVER indicator

Remote Control

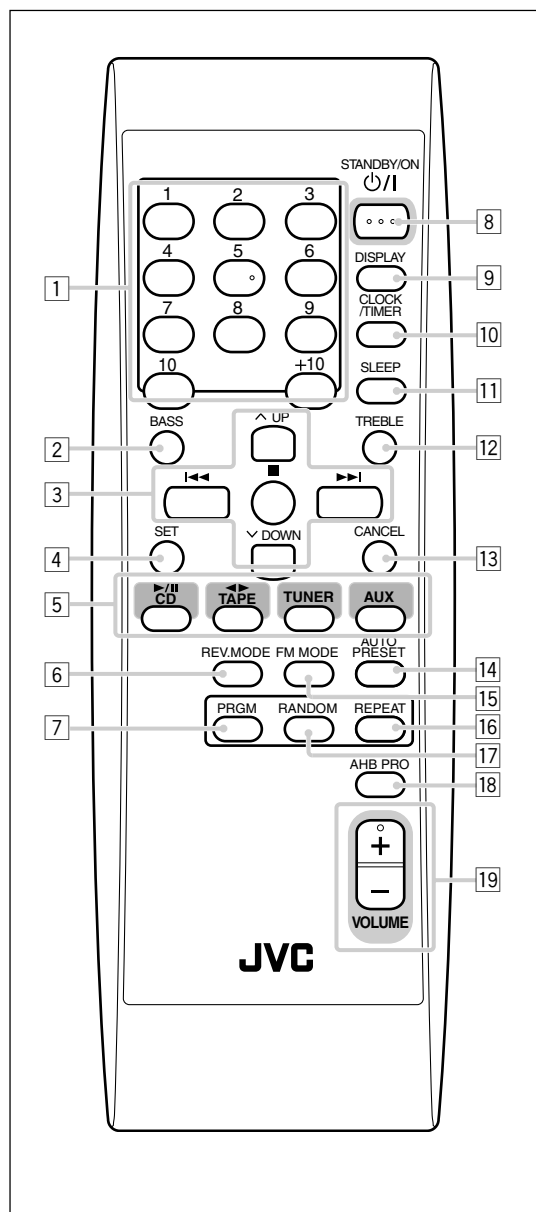

See the pages in parentheses for details.

- 1 Number buttons
- 2 BASS button (11)
- 3 Multi control buttons
 - ▲ UP, ◀◀ (reverse skip), ■ (stop), ▶▶ (forward skip), and ▼ DOWN
- 4 SET button (13)
- 5 Source buttons
 - ▶/|| CD, ◀◀ TAPE, TUNER, and AUX
 Pressing one of these buttons also turns on the unit.
- 6 REV.MODE (reverse mode) button (17 – 19)
- 7 PRGM (program) button (15)
- 8 STANDBY/ON ⏻/⏻ button (11, 21)
- 9 DISPLAY button (10)
- 10 CLOCK/TIMER button (10, 20, 21)
- 11 SLEEP button (22)
- 12 TREBLE button (11)
- 13 CANCEL button (16)
- 14 AUTO PRESET button (12)
- 15 FM MODE button (12)
- 16 REPEAT button (16)
- 17 RANDOM button (16)
- 18 AHB (Active Hyper Bass) PRO button (11)
- 19 VOLUME + / - button (11)

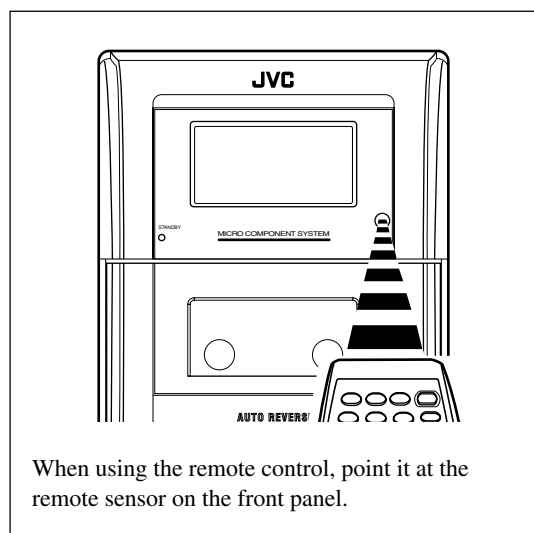

When using the remote control, point it at the remote sensor on the front panel.

Supplied Accessories

Make sure that you have all the following items. The number in parentheses indicates the quantity of each piece supplied.

- AM loop antenna (1)
- FM antenna (1)
- AC power cord (1)
- AC plug adapter (1)
- Remote control (1)
- Batteries (2)

If anything is missing, consult your dealer immediately.

Connecting Antennas

FM antenna

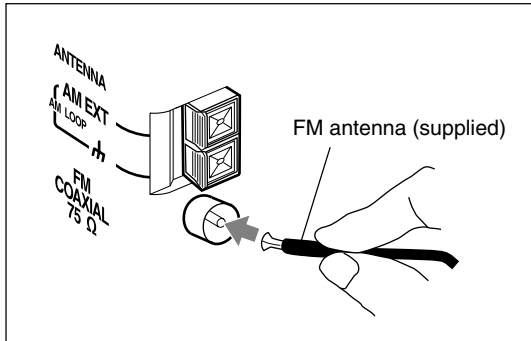

- 1 **Attach the FM antenna to the FM COAXIAL 75 Ω terminal.**
- 2 **Extend the FM antenna.**
- 3 **Fasten it up in the position which gives you the best reception, then fix it on the wall, etc.**



About the supplied FM antenna

The FM antenna supplied with this unit can be used as temporary measure. If reception is poor, you can connect an outdoor FM antenna.

To connect an outdoor FM antenna

Before connecting the antenna, disconnect the supplied FM antenna.

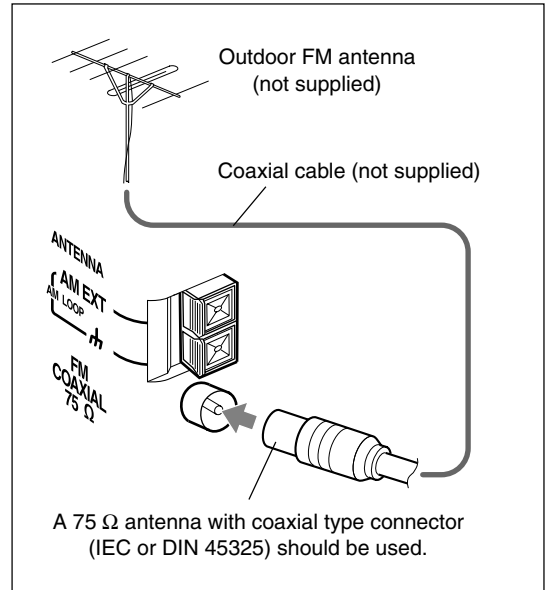

AM antenna

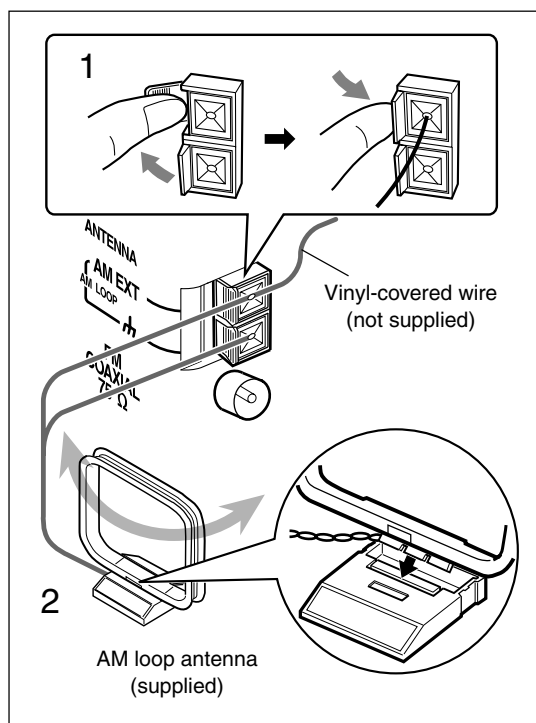

- 1 Connect the AM loop antenna to the AM LOOP terminals as illustrated.
- 2 Turn the AM loop antenna until you have the best reception.

To connect an outdoor AM antenna

When reception is poor, connect a single vinyl-covered wire to the AM EXT terminal and extend it horizontally. The AM loop antenna must remain connected.



For better reception of both FM and AM

- Make sure the antenna conductors do not touch any other terminals and connecting cords.
- Keep the antennas away from metallic parts of the unit, connecting cords, and the power cord.

Connecting Speakers

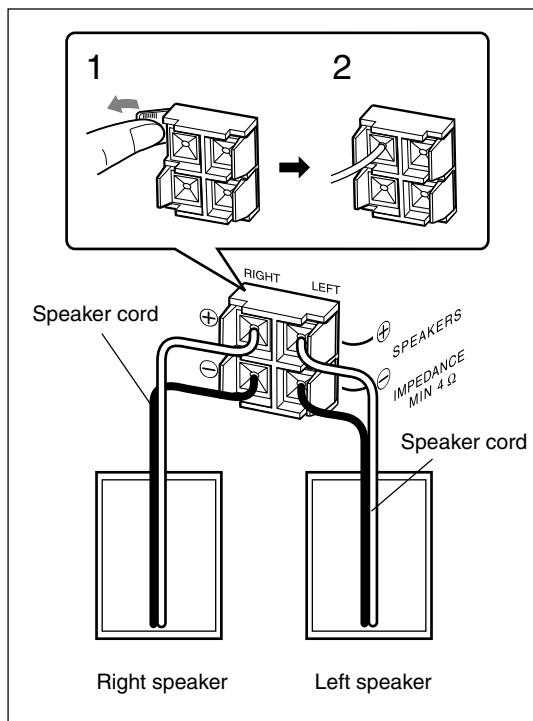

- 1 Press and hold the clamp of the speaker terminal on the rear of the unit.
- 2 Insert the end of the speaker cord into the terminal.
Match the polarity between the unit and the speaker terminals: \oplus to \oplus and \ominus to \ominus .
- 3 Release your finger from the clamp.



- DO NOT connect speakers while the power is on.
- DO NOT connect more than one speaker to each speaker terminal.

IMPORTANT: Use only speakers with the same speaker impedance as shown on the speaker terminals on the rear of the unit.

To remove the speaker grilles

The speaker grilles are removable.

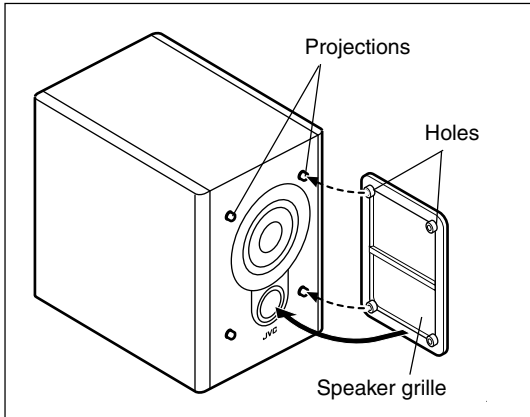

To remove the speaker grille, insert your fingers at the top of the speaker grille, pull towards you. Then pull the bottom towards you.

To attach the speaker grille, follow the illustration above.

Connecting Other Equipment

To connect an audio equipment

You can connect audio equipment—used only as a playback device.



- DO NOT connect any equipment while the power is on.
- DO NOT plug in any equipment until all connections are complete.

Be sure that the plugs of the audio cords are colored: White plugs and jacks are for left audio signals, and red ones for right audio signals.

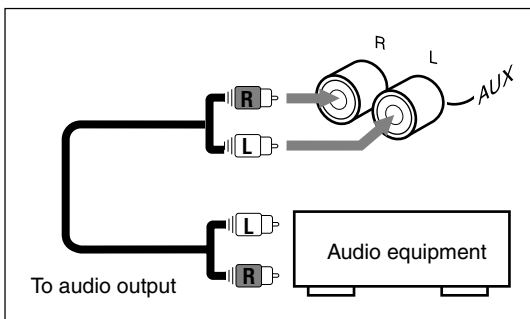

For playing other equipment through this unit, connect between the audio output jacks on the other equipment and AUX jacks by using audio cords (not supplied).

Adjusting the Voltage Selector

Before plugging in the unit, set the correct voltage for your area with the voltage selector on the rear of the unit.

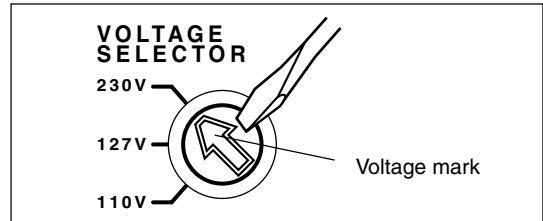

Use a screwdriver to rotate the voltage selector so the voltage number the voltage mark is pointing at is the same as the voltage where you are plugging in the unit. (See the back cover page.)



DO NOT plug in before setting the voltage selector on the rear of the unit and all connection procedures are complete.

NOW you are ready to plug in the unit and any other connected equipment.

IMPORTANT: Be sure to check all connections to be done before plugging the power cord.

This unit can be supplied with power through the AC IN connector (at home) or the DC IN connector (in a car).

- Do not connect the unit using the AC IN connector and the DC IN connector at the same time for safe and correct use.

To connect the AC power cord

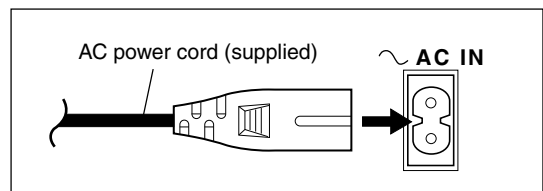

Connect the AC power cord to the AC IN connector and a wall outlet.

- If the wall outlet does not match the AC plug, use the supplied AC plug adaptor.

When using the unit in your car

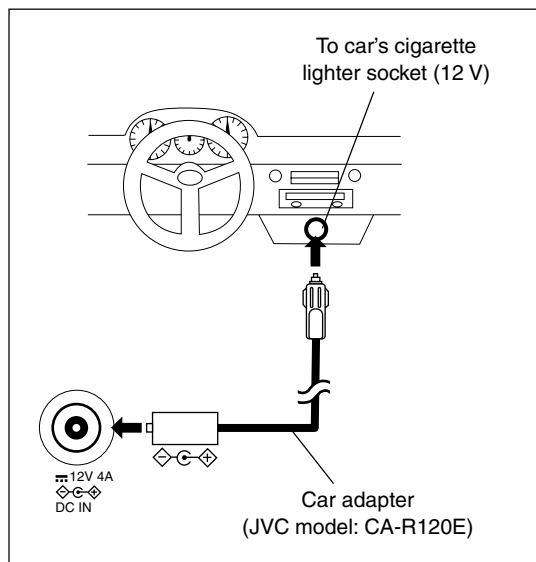

Connect a car adapter to the DC IN (12 V, 4 A) connector and the cigarette lighter socket.



- DO NOT connect the car adapter to the cigarette lighter socket before connecting it to the DC IN connector. Otherwise, a short-circuit may occur if the adapter plug makes contact with any metal part inside the car.
- DO NOT use this unit for a long time in a car while the car ignition switch is turned "OFF" (or set to "ACC"). Otherwise, the car battery will be exhausted.

Putting the Batteries into the Remote Control

Insert the batteries—R6(SUM-3)/AA(15F)—into the remote control, by matching the polarity (+ and -) on the batteries with the + and - markings on the battery compartment.

When the remote control can no longer operate the unit, replace both batteries at the same time.

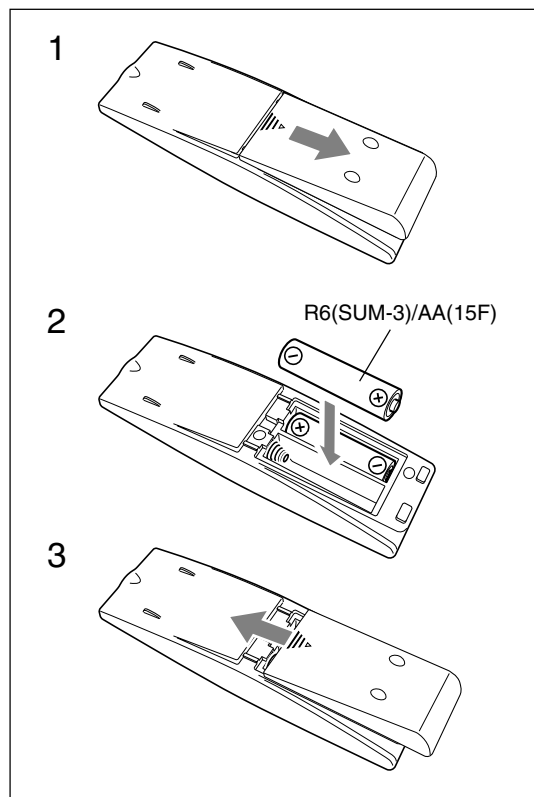

- DO NOT use an old battery together with a new one.
- DO NOT use different types of batteries together.
- DO NOT expose batteries to heat or flame.
- DO NOT leave the batteries in the battery compartment when you are not going to use the remote control for an extended period of time. Otherwise, the remote control will be damaged from battery leakage.

Setting the Clock

Before operating the unit any further, first set the unit's clock. When you plug in the power cord, the **CLOCK** indicator and "0:00" start flashing on the display. You can set the clock whether the unit is on or off.

- There is a time limit in doing the following steps. If the setting is canceled before you finish, start over from step 1.

On the remote control:

1 Press **CLOCK/TIMER**.

The hour digits start flashing on the display.

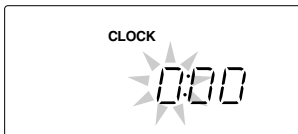

2 Press **^ UP** or **∨ DOWN** to adjust the hour, then press **CLOCK/TIMER**.

The minute digits start flashing.

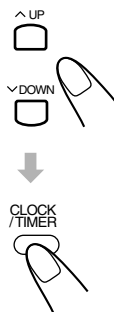

3 Press **^ UP** or **∨ DOWN** to adjust the minute, then press **CLOCK/TIMER**.

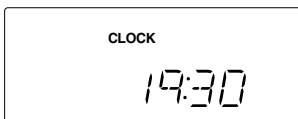

On the unit:

1 Press **TIMER/SNOOZE**.

The hour digits start flashing on the display.



2 Press **▶▶** or **◀◀** to adjust the hour, then press **TIMER/SNOOZE**.

The minute digits start flashing.

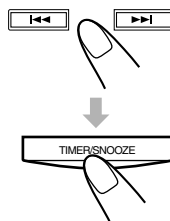

3 Press **▶▶** or **◀◀** to adjust the minute, then press **TIMER/SNOOZE**.

To check the clock time during play

On the remote control ONLY:

Press **DISPLAY** (grey-colored).

- Each time you press the button, the source indication and the clock time alternate on the display.



- **When you unplug the power cord or if a power failure occurs**
The clock is reset to "0:00" right away. If this happens, set the clock again.
- **The clock may gain or lose 1 to 2 minutes per month**
If this happens, reset the clock.

To change the clock

1 Make sure the **⊖** (timer) indicator is not lit on the display.

- If it is lit, press and hold **CLOCK/TIMER** (or **TIMER/SNOOZE** on the unit) until it goes off.

2 Press **CLOCK/TIMER** (or **TIMER/SNOOZE** on the unit) repeatedly until the unit enters the clock setting mode (the hour digits start flashing on the display).

First time you press **CLOCK/TIMER** (or **TIMER/SNOOZE** on the unit), the unit enters the timer setting mode. (See page 20.)

3 Repeat steps 2 and 3 of the procedure of "Setting the Clock."

4 Press and hold **CLOCK/TIMER** (or **TIMER/SNOOZE** on the unit) again so that the **⊖** (timer) indicator goes off.

Setting the AM Tuner Interval Spacing

Some countries space AM stations 9 kHz apart, and some countries use 10 kHz spacing.

When shipped, the built-in AM tuner is set to 9 kHz spacing. You can change it to 9 kHz or 10 kHz spacing only while the unit is on standby.

On the unit ONLY:

To select 10 kHz intervals, press **⊖/I** while holding **▶▶**.





To select 9 kHz intervals, press **⊖/I** while holding **◀◀**.







When you change the setting



The preset stations are erased. You will need to preset the stations again. (See page 12.)

Turning On the Power

To turn on the unit, press STANDBY/ON  (or  on the unit). The STANDBY lamp on the unit goes off.



- When you press the source button   CD,   TAPE, TUNER (or BAND TUNER on the unit) and AUX, the unit automatically turns on and starts playback if the source is ready.

To turn off the unit (standby), press STANDBY/ON  (or  on the unit) again. The STANDBY lamp on the unit lights on.

- The CLOCK indicator and “0:00” flash on the display until you set the built-in clock. After setting the clock, the clock time will appear on the display while the unit is on standby.
- A little power is always consumed even while the unit is on standby.

To switch off the power supply completely, unplug the power cord.



When you unplug the power cord or if a power failure occurs

The clock is reset to “0:00” right away, while the tuner preset stations (see page 12) will be erased in a few days.

Adjusting the Volume

You can adjust the volume level only while the unit is turned on. The volume level can be adjusted between “VOL MIN” and “VOLUME 1” – “VOLUME 40 (VOL MAX).”

Press VOLUME + to increase the volume or press VOLUME – to decrease it.

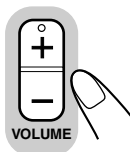

For private listening

Connect headphones to the PHONES jack. No sound comes out of the speakers. Be sure to turn down the volume before connecting or putting on headphones.



DO NOT turn the unit off (standby) with the volume set to an extremely high level; otherwise, the sudden blast of sound can damage your hearing, speakers and/or headphones when you turn on the unit or start playing any source next time. REMEMBER you cannot adjust the volume level while the unit is on standby.

Adjusting the Tone (Bass/Treble)

You can adjust the bass level (low frequency range) and the treble level (high frequency range) within a range of –5 to +5.



When shipped, the bass level set to “BASS 0” and the treble level set to “TREBLE +1.”

- This function only affects the playback sound, and does not affect your recording.
- There is a time limit in doing the following steps. If the setting is canceled before you finish, start over from step 1.

On the remote control ONLY:

1 Press BASS to adjust the bass level or press TREBLE to adjust the treble level.



2 Press  UP to increase the level or press  DOWN to decrease it.



Reinforcing the Bass Sound

You can reinforce the bass sound to maintain rich, full bass at low volume—Active Hyper Bass Pro.

- This function only affects the playback sound, and does not affect your recording.

To get the effect, press AHB PRO so that the **BASS** indicator lights up on the display.



- Each time you press the button, the bass reinforcement alternates between on (AHB ON) and off (AHB OFF).

To cancel the effect, press AHB PRO again so that the **BASS** indicator goes off.

Tuning in to a Station

1 Press TUNER (or BAND TUNER on the unit) to select the band.

The unit automatically turns on and tunes in to the previously received station—either FM or AM.

- Each time you press the button, the band alternates between FM and AM.

FM 87.50

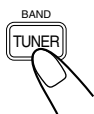
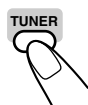

2 Press and hold ►► or ◄◄ for more than 1 second.

The unit starts searching for stations and stops when a station of sufficient signal strength is tuned in.

- If a program is broadcast in stereo, the STEREO indicator lights up.

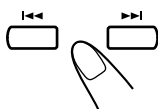

To stop searching, press ►► or ◄◄.



When you press ►► or ◄◄ briefly and repeatedly

The frequency changes step by step.

To change the FM reception mode

On the remote control ONLY:

When an FM stereo broadcast is hard to receive or noisy, press FM MODE so that the MONO indicator lights up on the display. Reception will improve.



To restore the stereo effect, press FM MODE again so that the MONO indicator goes off. In stereo mode, you can hear stereo sound when a stereo program is broadcast.

Presetting Stations

You can preset 30 FM and 15 AM stations—using either automatic presetting or manual presetting. In some cases, test frequencies have been already memorized for the tuner since the factory examined the tuner preset function before shipment. This is not a malfunction.

To preset stations automatically—Automatic presetting

You need to preset stations separately for the FM and AM bands.

On the remote control ONLY:

1 Press TUNER to select the band.

The unit automatically turns on and tunes in to the previously received station—either FM or AM.

- Each time you press the button, the band alternates between FM and AM.

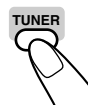

2 Press and hold AUTO PRESET for more than 2 seconds.

Local stations with strong signals are searched for and stored in memory automatically. When automatic presetting is over, the station stored in preset number 1 is tuned in.

- Storing new stations erase the previously stored one.



3 Repeat steps 1 and 2 to store stations for the other band.



When you cannot automatically store stations you want

Stations with weak signals cannot be detected with automatic presetting. To store such stations, use manual presetting.

To preset stations manually—Manual presetting

You need to preset stations separately for the FM and AM bands.

- There is a time limit in doing the following steps. If the setting is canceled before you finish, start over from step 2.

On the remote control ONLY:

1 Tune in to the station you want to preset.

- See “Tuning in to a Station” on page 12.

2 Press SET.



3 Press ^ UP or v DOWN to select a preset number.

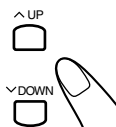

4 Press SET again.



The tuned station in step 1 is stored in the preset number selected in step 3.

- Storing a new station on a used number erases the previously stored one.



When you unplug the power cord or if a power failure occurs

The tuner preset stations will be erased in a few days. If this happens, preset the stations again.

Tuning in to a Preset Station

On the remote control ONLY:

1 Press TUNER to select the band.

The unit automatically turns on and tunes in to the previously received station—either FM or AM.

- Each time you press the button, the band alternates between FM and AM.

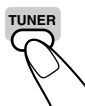

2 Press ^ UP or v DOWN to select a preset number.

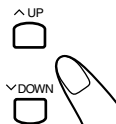

To tune in to a preset station directly using the number buttons

On the remote control ONLY:

Pressing the number button(s) allows you to select the preset number you want.

Ex.: For preset number 5, press 5.

For preset number 15, press +10, then 5.

For preset number 20, press +10, then 10.

For preset number 30, press +10, +10, then 10.

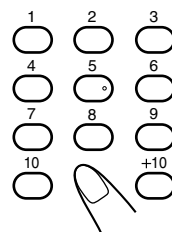

This unit has been designed to play back the following discs—CD, CD-R, and CD-RW.

When playing a CD-R or CD-RW

User-edited CD-Rs (CD-Recordable) and CD-RWs (CD-ReWritable) can be played only if they are already “finalized.”

- Usually you can play back your original CD-Rs or CD-RWs recorded in music CD format. However, sometimes they may not play depending on their characteristics or recording conditions.
- Before playing CD-Rs or CD-RWs, read their instructions or cautions carefully.
- Some CD-Rs or CD-RWs may not play on this unit because of their disc characteristics, damage or stain on them, or if the player’s lens is dirty.
- CD-RWs may require a longer readout time. This is because the reflectance of CD-RWs is lower than for regular discs.

General notes

In general, you will have the best performance by keeping your discs and the mechanism clean.

- Store discs in their cases, and keep them in cabinets or on shelves.
- Keep the unit’s disc cover closed when not in use.

Continued use of irregular shape discs (heart-shape, octagonal, etc.) can damage the unit.

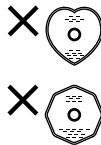

Playing Back the Entire Disc—Normal Play

1 Press OPEN on the unit.

The disc cover opens.

- You can insert a disc while listening to another source.

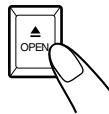

2 Place a disc correctly with its label side up.

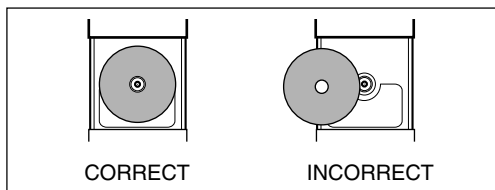

3 Close the disc cover gently.

4 Press CD.

The unit automatically turns on and the first track of the disc starts playing.

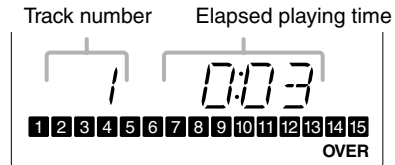
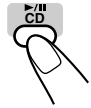

- The track number that has already played disappears from the track calendar on the display.
- The disc automatically stops when the last track has finished playing.

To stop playing, press .

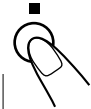
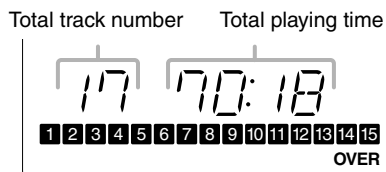

To remove the disc, press  OPEN on the unit.



- **If the disc cannot be read correctly (because it is scratched, for example) or an unreadable CD-R or CD-RW is inserted**
Playback will not start.
- **If no disc is inserted**
“NO DISC” appears on the display.
- **If the loaded disc has more than 15 tracks**
The OVER indicator lights on the display.



DO NOT try to open the disc cover by hand as it will be damaged.

Basic Disc Operations

While playing a disc, you can do the following operations.

To stop playing for a moment

During play, press ►/|| CD.

While pausing, the elapsed playing time flashes on the display.



To resume playing, press ►/|| CD again.

To go to another track

Before or during play, press ►►1 or ◀◀1 repeatedly.

- ►►1: Skips to the beginning of the next or succeeding tracks.
- ◀◀1: Goes back to the beginning of the current or previous tracks.

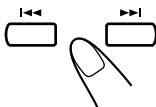

To go to another track directly using the number buttons

On the remote control ONLY:

Pressing the number button(s) before or during play allows you to start playing the track number you want.

Ex.: For track number 5, press 5.

For track number 15, press +10, then 5.

For track number 20, press +10, then 10.

For track number 32, press +10, +10, +10, then 2.

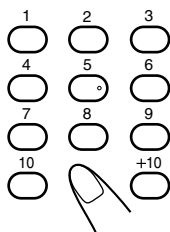

To locate a particular point in a track

During play, press and hold ►►1 or ◀◀1.

- ►►1: Fast-forwards the tracks.
- ◀◀1: Fast-reverses the tracks.

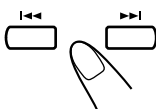

Programming the Playing Order of the Tracks—Program Play

You can arrange the order in which tracks play before you start playing. You can program up to 20 tracks.

On the remote control ONLY:

1 Load a disc.

- If the current playing source is not the CD player, press ►/|| CD, then ■ before going to the next step.

2 Press PRGM (program).

The PROGRAM indicator lights up on the display.

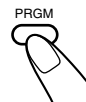

- If a program has been stored in memory, the program is called up.

3 Press ^ UP or v DOWN to select the track number, then press SET.

- You can select the track number directly using the number button(s). (See “To go to another track directly using the number buttons.”)

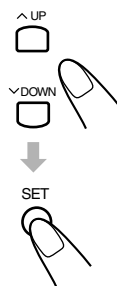

Track number



Program step number

4 Repeat step 3 to program other tracks you want.

5 Press ►/|| CD.

The tracks are played in the order you have programmed.



If you try to program a 21st track “FULL” will appear on the display.

To stop playing, press ■.



To exit from Program Play, press PRGM (program) before or after playing.

- The PROGRAM indicator goes off.

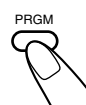

To check the program contents

You can check the program contents by pressing ►►| or |◄◄ before or after playback.

- ►►| : To check the contents in the programmed order.
- |◄◄ : To check the contents in the reverse order.

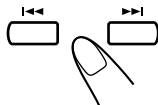

To skip the current track, press ►►|.

- You cannot go back to the previous track by pressing |◄◄.



To modify the program

On the remote control ONLY:

Before or after playing, you can erase the last programmed track by pressing CANCEL.

- Each time you press the button, the last programmed track is erased from the program.



To add tracks in the program before playing, simply select the track numbers you want to add by following step 3 of the programming procedure.

To erase the program, press ■ before or after playing.

- Pressing ▲ OPEN to open the disc cover will also erase the programmed tracks.



Playing at Random—Random Play

The tracks will play in no particular order when you use this mode.

On the remote control ONLY:

1 Load a disc.

- If the current playing source is not the CD player, press ►/|| CD, then ■ before going to the next step.

2 Press RANDOM.

The RANDOM indicator lights up on the display.



3 Press ►/|| CD.

The tracks are randomly played. Random Play ends when all the tracks are played once.



To stop playing, press ■.



To exit from Random Play, press RANDOM before or after playing.

Random Play is canceled and Normal Play resumes.

- The RANDOM indicator goes off.



Repeating Tracks—Repeat Play

You can have all the tracks, the program or individual track currently playing, repeat as many times as you like.

On the remote control ONLY:

To repeat playing, press REPEAT before or during play.

- Each time you press the button, Repeat Play changes as follows, and the following repeat indicator lights up on the display:

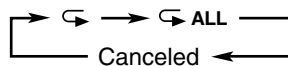
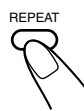

↶ : Repeats one track.

↶ ALL : In Normal Play, repeats all the tracks.

In Program Play, repeats all the tracks in the program.

In Random Play, repeats all the tracks in random order.

To cancel Repeat Play, press REPEAT repeatedly until the repeat indicator goes off.

- Repeat Play remains in effect even when you select another play mode (Normal, Program or Random Play).

- In Random Play, ↶ cannot be selected. If ↶ has been selected when you press RANDOM, it is canceled.

Playing Back Tapes

You can play back type I tapes.

Playing Back a Tape

1 Press for cassette deck on the unit.

The cassette holder opens.

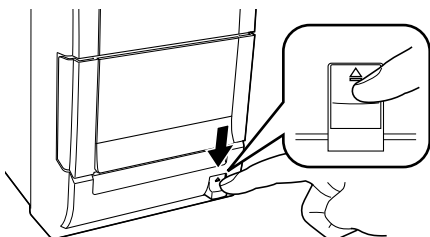

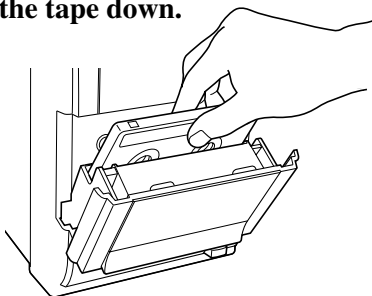

2 Put a cassette in with the exposed part of the tape down.



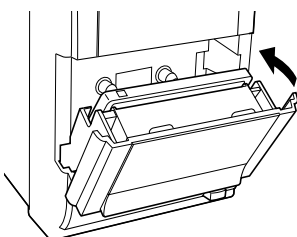



3 Close the cassette holder cover gently.



4 Press TAPE.

The unit automatically turns on and the tape starts playing. The tape direction indicator ( or ) flashes slowly on the display.

- Each time you press the button, the tape direction changes:
 -  : plays the front side.
 -  : plays the reverse side.

When the tape plays to the end, the deck automatically stops if the Reverse Mode is set to  or . (See “To play both sides—Reverse Mode.”)





If no cassette is inserted when you press



 TAPE

“NO TAPE” appears on the display.

To stop playing, press .



To fast-wind to the left or to the right, press  or  while the tape is not running.

The tape direction indicator ( or ) starts flashing rapidly on the display.

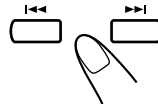

To remove the cassette, press  on the unit.



To play both sides—Reverse Mode

You can set the deck to play just one side of a tape, both sides once, or both sides continuously.





On the remote control ONLY:

Press REV.MODE (reverse mode).

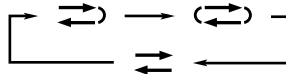
- Each time you press the button, the Reverse Mode changes as follows:

REV.MODE



-  : The deck automatically stops after playing both sides of the tape. Stops when playback in the  direction is finished.
-  : The deck continues to play both sides of the tape until  is pressed.
-  : The deck automatically stops after playing one side of the tape.



The use of C-120 or thinner tape is not recommended, since characteristic deterioration may occur and this tape easily jams in the pinch-rollers and the capstans.

IMPORTANT:

- It may be unlawful to record or play back copyrighted material without the consent of the copyright owner.
- The recording level is automatically set correctly, so it is not affected by the other sound settings. Thus, during recording you can adjust the sound you are actually listening to without affecting the recording level.
- If recordings you have made have excessive noise or static, the unit may be too close to a TV. Increase the distance between the TV and the unit.
- You can use type I tape for recording.

To protect your recording

Cassettes have two small tabs on the back to protect from unexpected erasure or re-recording.

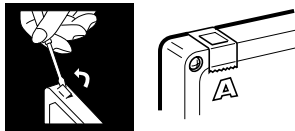

To protect your recording, remove these tabs.

To re-record on a protected tape, cover the holes with adhesive tape.



At the start and end of cassette tapes

There is leader tape which cannot be recorded onto. Thus, when recording discs or radio broadcasts, wind the leader tape first to ensure that the recording will be made without any loss.

Recording on a Tape

On the unit ONLY:

- 1 Put a recordable cassette in with the exposed part of the tape down.**

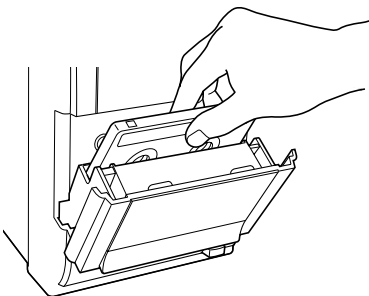

- 2 Close the cassette holder gently and check the recording direction for the tape.**

- If the tape direction is not correct, press ◀▶ TAPE twice then ■ to change the tape direction.
- If you want to record on both sides of a tape, see “To record on both sides—Reverse Mode.”

- 3 Start playing the source—FM, AM or auxiliary equipment connected to AUX jacks.**

- When the source is the CD player, see “Disc Direct Recording” on page 19.

- 4 Press ONE TOUCH REC (recording).**

The **REC** (recording) indicator lights up on the display and recording starts.



- If no cassette is inserted when you press REC “NO REC” appears on the display.
- If a protected tape is inserted when you press REC “NO REC” appears on the display.

To stop while recording, press ■.

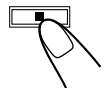

To remove the cassette, press △ on the unit.



To record on both sides—Reverse Mode

On the remote control ONLY:

Press REV.MODE (reverse mode) repeatedly until ⇌ or ⇐⇒ is lit.

- When using the Reverse Mode for recording, ⇌ lights up and start recording in the forward (▶) direction first. Otherwise, recording will stop when recording is done only on one side (reverse) of the tape.



Disc Direct Recording

Everything on the disc goes onto the tape in the order it is on the disc, or according to the order you have set in Program Play.

On the unit ONLY:

1 Put a recordable cassette in with the exposed part of the tape down.

2 Load a disc.

- If the current playing source is not the CD player, press ►/|| CD, then ■ before going to the next step.
 - If you do not want pauses of about 4 seconds recorded between selections, press ►/|| CD twice. Otherwise, a non-recorded pause will be automatically inserted between selections.
- If you want to record on both sides of a tape, see “To record on both sides—Reverse Mode.”

3 Press ONE TOUCH REC (recording).

The **REC** (recording) indicator lights up on the display and recording starts. After recording, the CD player and cassette deck automatically stop.



To stop while recording, press ■. The tape stops after 4 seconds.



To remove the cassette, press △ on the unit.



To record on both sides—Reverse Mode

On the remote control ONLY:

Press **REV.MODE** (reverse mode) repeatedly until ⇄ or ⇄ is lit.



- When using the Reverse Mode for Disc Direct Recording, ⇄ lights up and start recording in the forward (►) direction first. When the tape reaches its end while recording a song in the forward direction (►), the last song will be re-recorded at the beginning of the reverse side (◄). If you start recording on the reverse side (◄), recording will stop when recording is done only on one side (reverse) of the tape.



When making Sleep Timer settings while doing Disc Direct Recording

Set enough time to allow for the disc to finish playing; otherwise, the power will go off before recording is completed.

One Track Recording

This recording method is convenient when you record tracks while playing the disc. You can record just your favorite songs on the tape.

On the unit ONLY:

1 Put a recordable cassette in with the exposed part of the tape down.

2 Play the track on the disc you wish to record.

3 Press ONE TOUCH REC (recording).

The CD player returns to the beginning of that track and the track is recorded on the tape. After recording, the CD player and cassette deck automatically stop.

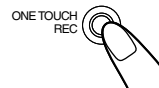

4 Repeat steps 2 and 3 to record other tracks you want.

To stop while recording, press ■. The tape stops after 4 seconds.



To remove the cassette, press △ on the unit.



There are four timers available—Daily Timer, Recording Timer, Snooze Timer, and Sleep Timer. Before using the timers, you need to set the unit's clock (see page 10).



Using Daily Timer and Recording Timer

You can set the timer whether the unit is on or off.

How the timer actually works

When the on-time comes, the unit automatically turns on (the  [timer] indicator flashes just before the on-time and continues flashing while the timer is operating). Then, when the off-time comes, the unit automatically turns off (standby).

The timer setting remains in memory until you change it.

- When the  (timer) indicator is lit on the display, the timer acts as the Daily Timer. Once the timer has been set, it will be activated at the same time everyday until the timer is turned off.
- When the  (timer) and the REC indicators are lit on the display, the timer acts as the Recording Timer. After the timer-recording finishes, the details of the setting remain stored but the timer is turned off.

Before you start...

When using "TUNER" as the source to play, make sure to select the desired station before turning off the power.

- There is a time limit in doing the following steps. If the setting is canceled before you finish, start over from step 1.

1 Press CLOCK/TIMER (or TIMER/SNOOZE on the unit).



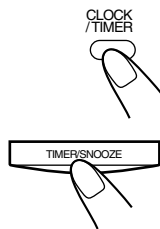

The  (timer) and the ON indicators light up and the current on-time flashes on the display.

The unit enters on-time setting mode.





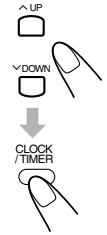

2 Set the on-time when you want the unit to turn on.

On the remote control:

- 1) Press  UP or  DOWN to set the hour, then press CLOCK/TIMER.
- 2) Press  UP or  DOWN to set the minute, then press CLOCK/TIMER.



On the unit:

- 1) Press  or  to set the hour, then press TIMER/SNOOZE.
- 2) Press  or  to set the minute, then press TIMER/SNOOZE.

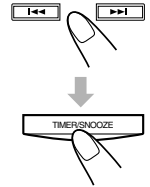



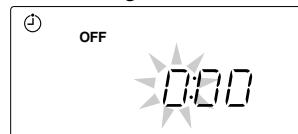

The OFF indicator lights up and the unit enters off-time setting mode.







3 Set the off-time when you want the unit to turn off (standby).

On the remote control:

- 1) Press  UP or  DOWN to set the hour, then press CLOCK/TIMER.
- 2) Press  UP or  DOWN to set the minute, then press CLOCK/TIMER.

On the unit:

- 1) Press  or  to set the hour, then press TIMER/SNOOZE.
- 2) Press  or  to set the minute, then press TIMER/SNOOZE.

The unit enters the timer selecting mode.

4 Select the timer (Daily Timer or Recording Timer) with the source to play.

On the remote control:

Press **▲ UP** or **▼ DOWN** to select the timer, then press **CLOCK/TIMER**.

On the unit:

Press **▶▶|** or **|◀◀** to select the timer, then press **TIMER/SNOOZE**.

- Each time you press **▲ UP** (**▶▶|**) or **▼ DOWN** (**|◀◀**), the timer mode and the source change as follows:

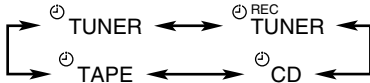

TUNER : tunes in to the last station you were listening to. (Daily Timer)

REC TUNER : records the last station you were listening to. (Recording Timer)

- Put a recordable cassette into the deck.

CD : plays a disc. (Daily Timer)

- Load a disc.

TAPE : plays a tape. (Daily Timer)

- Make sure that the tape is in the cassette deck.
- Make sure that the tape direction is correct.

The unit enters the volume level setting mode.

5 Select the volume level.

On the remote control:

Press **▲ UP** or **▼ DOWN** to set the volume level, then press **CLOCK/TIMER**.

On the unit:

Press **▶▶|** or **|◀◀** to set the volume level, then press **TIMER/SNOOZE**.

- You can select the volume level (“VOLUME – –” and “VOLUME 0” to “VOLUME 40”).

If you select “VOLUME – –,” the volume is set to the previous level when the unit was turned off.

- To turn off the volume while the Recording Timer (**REC TUNER**) is working, set the volume level “VOLUME 0.”

The unit enters the clock setting mode.

6 Adjust the clock if you need.

- See “Setting the Clock” on page 10.

7 Press **STANDBY/ON** **⏻/⏻** (or **⏻/⏻** on the unit) to turn off the unit (standby) if you have set the timer with the unit turned on.

- When the timer turns on the unit, the **⏻** (timer) indicator starts flashing. (If the Recording Timer is selected in step 4, the **REC** indicator also starts flashing.)

To deactivate the timer temporarily, press and hold **CLOCK/TIMER** (or **TIMER/SNOOZE** on the unit) until the **⏻** (timer) indicator on the display goes off.

To activate or change the timer (with the previous setting), follow steps 1 to 7 on pages 20 and 21.

- If you want to change the timer setting after the Daily Timer be used, first deactivate the timer.



- **If the unit is turned on when the timer on-time comes** Timer does not work.
- **When you unplug the power cord or if a power failure occurs**

The timer will be canceled. You need to set the clock first, then the timer again.

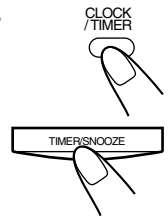
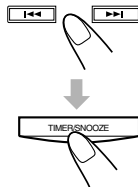
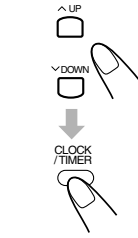

Using Snooze Timer

The Snooze Timer turns off the unit (standby) only for 5 minutes while the Daily Timer is in operation.

- You can set the Snooze Timer only while the Daily Timer is in operation.

Press TIMER/SNOOZE on the unit (or CLOCK/TIMER on the remote control) while the Daily Timer is in operation.

The unit turns off (standby) and the **SNOOZE** indicator lights up on the display. After 5 minutes, the unit automatically turns on.



- **If the unit is turned on when the Snooze Timer is working**
The Snooze Timer and the Daily Timer will be canceled.
- **If you set the Snooze Timer when there is less than 5 minutes until the Daily Timer off-time**
The unit will not turn on even when 5 minutes passed.
- **When you unplug the power cord or if a power failure occurs**
The timer will be canceled. You need to set the clock first, then the timer again.

Using Sleep Timer

With the Sleep Timer, you can fall asleep to music. You can set the Sleep Timer when the unit is turned on.

How the Sleep Timer actually works

The unit automatically turns off after the specified time length passes.

On the remote control ONLY:

1 Press SLEEP.

The time length until the shut-off time appears and the **SLEEP** indicator lights up on the display.

- Each time you press the button, the time length changes as follows:

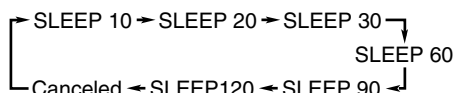

2 Wait for about 5 seconds after specifying the time length.

To check the remaining time until the shut-off time, press SLEEP once so that the remaining time until the shut-off time appears for about 5 seconds.

To change the shut-off time, press SLEEP repeatedly until the desired time length appears on the display.

To cancel the setting, press SLEEP repeatedly until the **SLEEP** indicator goes off.

- The Sleep Timer is also canceled when you turn off the unit.



- **If you set the Sleep Timer after the Daily Timer starts playing the selected source**
The Daily Timer is canceled. When the Sleep Timer shut-off time comes, the unit will be turned off.
- **If you set the Sleep Timer after the Recording Timer starts recording**
The Recording Timer is canceled, but recording continues until the Sleep Timer shuts off the power.

Maintenance

To get the best performance from the unit, keep your discs, tapes, and mechanism clean.

Cleaning the unit

• Stains on the unit

Should be wiped off with a soft cloth. If the unit is heavily stained, wipe it with a cloth soaked in water-diluted neutral detergent and wrung well, then wipe clean with a dry cloth.

• Since the unit may deteriorate in quality, become damaged or have its paint peel, be careful about the following:

- DO NOT wipe it with a rough cloth.
- DO NOT wipe it strongly.
- DO NOT wipe it with thinner or benzine.
- DO NOT apply any volatile substances such as insecticides to it.
- DO NOT allow any rubber or plastic to remain in contact with it for a long time.

Handling discs

- Remove the disc from its case by holding it at the edge while pressing the center hole lightly.
- Do not touch the shiny surface of the disc, or bend the disc.
- Put the disc back in its case after use to prevent warping.



- Be careful not to scratch the surface of the disc when placing it back in its case.
- Avoid exposure to direct sunlight, temperature extremes, and moisture.

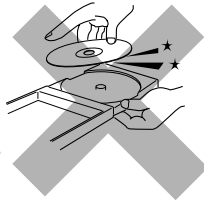

To clean the disc

Wipe the disc with a soft cloth in a straight line from center to edge.



DO NOT use any solvent—such as conventional record cleaner, spray, thinner, or benzine—to clean the disc.

Handling cassette tapes

- If the tape is loose in its cassette, take up the slack by inserting a pencil in one of the reels and rotating.
- If the tape is loose, it may get stretched, cut, or caught in the cassette.
- Be careful not to touch the tape surface.
- Avoid storing tapes in the following places:
 - In dusty places
 - In direct sunlight or heat
 - In moist areas
 - On a TV or speaker
 - Near a magnet

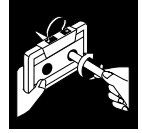

To keep the best recording and playback sound quality

If the heads, capstans, and pinch rollers of the cassette deck become dirty, the following will occur:

- Impaired sound quality
- Discontinuous sound
- Fading
- Incomplete erasure
- Difficulty in recording

To clean the heads, capstans, and pinch rollers

Use a cotton swab moistened with alcohol.

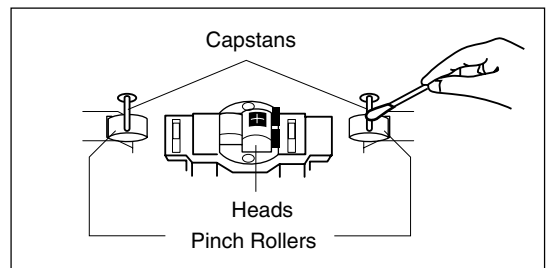

To demagnetize the heads

Turn off the unit, and use a head demagnetizer (available at electronics and audio shops).

Troubleshooting

If you are having a problem with your unit, check this list for a possible solution before calling for service. If you cannot solve the problem from the hints given here, or the unit has been physically damaged, call a qualified person, such as your dealer, for service.

Symptom	Cause	Action
No sound is heard.	<ul style="list-style-type: none"> • Connections are incorrect or loose. • Headphones are connected. 	<ul style="list-style-type: none"> • Check all connections and make corrections. (See pages 6 – 9.) • Disconnect the headphones.
Hard to listen to broadcasts because of noise.	<ul style="list-style-type: none"> • Antennas are disconnected. • The AM loop antenna is too close to the unit. • The FM antenna is not properly extended and positioned. 	<ul style="list-style-type: none"> • Reconnect the antennas correctly and securely. • Change the position and direction of the AM loop antenna. • Extend the FM antenna to the best position.
The disc does not play.	The disc is placed upside down.	Place the disc with the label side up.
The disc sound is discontinuous.	The disc is scratched or dirty.	Clean or replace the disc. (See page 23.)
The cassette holder cannot be opened.	Power from the power cord has been cut off while the tape was running.	Plug in the power cord, then turn on the unit.
Impossible to record.	Small tabs on the back of the cassette are removed.	Cover the holes with adhesive tape.
Operations are disabled.	The built-in microprocessor may malfunction due to external electrical interference.	Unplug the power cord and then plug it back in.
Unable to operate the unit from the remote control.	<ul style="list-style-type: none"> • The path between the remote control and the remote sensor on the unit is blocked. • The batteries are exhausted. 	<ul style="list-style-type: none"> • Remove the obstruction. • Replace the batteries.

Specifications

Design and specifications are subject to change without notice.

Amplifier

Output Power: 20 W (10 W + 10 W) at 4 Ω (10% THD)
 Audio input sensitivity/Impedance (at 1 kHz)
 AUX: 500 mV/48.75 k Ω
 Speakers/Impedance: 4 Ω

Tuner

FM tuning range: 87.50 MHz – 108.00 MHz
 AM tuning range:
 AM 10 kHz intervals: 530 kHz – 1 710 kHz
 AM 9 kHz intervals: 531 kHz – 1 710 kHz

CD player

Dynamic range: 85 dB
 Signal-to-noise ratio: 90 dB
 Wow and flutter: Immeasurable

Cassette deck

Frequency response:
 Normal (type I): 50 Hz – 15 000 Hz
 Wow and flutter: 0.15% (WRMS)

Speaker

Speaker units:
 Full range: 8.0 cm cone x 1
 Impedance: 4 Ω
 Dimensions (approx.):
 135 mm x 203 mm x 190 mm (W/H/D)
 Mass (approx.): 1.7 kg each

Supplied Accessories

See page 6.

General

Power requirement:
 AC IN: 110 V/ 127 V/ 230 V \sim ,
 adjustable with the voltage selector, 50 Hz/ 60 Hz
 DC IN: 12 V, 4 A
 Power consumption: 35 W (at operation)
 3.0 W (on standby)
 Dimensions (approx.):
 412 mm x 208 mm x 275 mm (W/H/D)
 Mass (approx.): 6.5 kg

Mains (AC) Line Instruction (not applicable for Europe, U.S.A., Canada, Australia, and U.K.)

主 (AC) 电源线路说明 (不适用于欧洲、美国、加拿大、澳洲及英国型号)

VOLTAGE SELECTOR

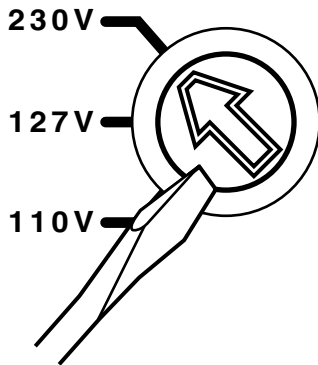

IMPORTANT for mains (AC) line

BEFORE PLUGGING IN, do check that your mains (AC) line voltage corresponds with the position of the voltage selector switch provided on the outside of this equipment and, if different, reset the voltage selector switch, to prevent from a damage or risk of fire/electric shock.

有关主 (AC) 电源线路的重要事项

接插电源以前，务请检查当地的主 (AC) 电源线路电压是否和位于本机外面的电压选择开关设定的位置一致。如果不一致，即重新设定电压选择开关使符合当地电压，以免损坏机器或引起火灾/触电的危险。

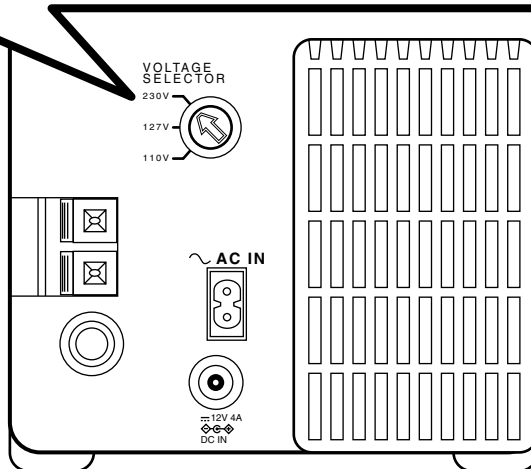

JVC

VICTOR COMPANY OF JAPAN, LIMITED